

Operating Instructions & User's Information Manual

VIESSMANN®

Please file in Service Binder

Vitodens 200-W

WB2B Series

Wall-mounted, gas-fired condensing boiler

For natural gas

Heating input 31 to 370 MBH

9 to 105 kW



VITODENS 200®



IMPORTANT

Read and save these instructions for future reference.



WARNING

If the information in this manual is not followed exactly, a fire or explosion may result causing property damage, personal injury or loss of life.

Do not store or use gasoline or other flammable liquids in the vicinity of this or any other appliance.

WHAT TO DO IF YOU SMELL GAS

- Do not try to light any appliances.
- Do not touch any electrical switches, do not use any phone in your building.
- Immediately call your gas supplier from a neighbor's phone. Follow the gas supplier's instructions.
- If you cannot reach your gas supplier, call the fire department.

Installation and service must be performed by a qualified installer, service agency or the gas supplier.

WARNING

Improper installation, adjustment, and/or operation could cause carbon monoxide poisoning resulting in injury or loss of life.

This product must be installed and serviced by a professional service technician who is experienced and qualified in hot water boiler installation and gas combustion.

Safety, Installation and Warranty Requirements

Please ensure that these instructions are read and understood before commencing installation. Failure to comply with the instructions listed below and details printed in this manual can cause **product/property damage, severe personal injury, and/or loss of life**. Ensure all requirements below are understood and fulfilled (including detailed information found in the manual subsections).

■ Licensed professional heating contractor

The installation, service, and maintenance of this equipment *must be performed* by a licensed professional heating contractor.

► Please see section entitled "Important Regulatory and Installation Requirements" in the Installation Instructions.

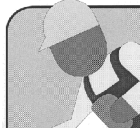

■ Carbon monoxide

Improper installation, service and/or maintenance can cause flue products to flow into living space. Flue products contain *poisonous* carbon monoxide gas.

► For information pertaining to the proper installation, service and maintenance of this equipment to avoid formation of carbon monoxide, please see the Installation Instructions of the Vitodens 200-W Direct Vent System.



■ Equipment venting

Never operate boiler without an *installed venting system*. An improper venting system can cause carbon monoxide poisoning.

■ Warranty

Information contained in this and related product documentation must be read and followed. *Failure to do so renders warranty null and void.*



■ Product documentation

Read all applicable documentation before commencing installation. Store documentation near boiler in a readily accessible location for reference in the future by service personnel.

► For a listing of applicable literature, please see section entitled "Important Regulatory and Installation Requirements" in the Installation Instructions.



 **WARNING**

Installers must follow local regulations with respect to installation of carbon monoxide detectors. Follow manufacturer's maintenance schedule of boiler.

■ Advice to owner

Once the installation work is complete, the heating contractor must familiarize the system operator/ultimate owner with all equipment, as well as safety precautions/requirements, shut-down procedure, and the need for professional service annually before the heating season begins.

	Page
General Information / Safety	
About these Instructions	5
Safety	
For your Safety	5
Inform Yourself	
Getting Started	9
Your Vitodens 200-W Boiler	10
Your System is Preset at the Factory	10
Overview of Controls and Indicators	11
Opening the control unit	11
Vitotronic 200 Type HO1 Functions	12
Heating system with two heating circuits	14
Start-up / Shutdown	
Starting the Heating System	15
Shutting Down the Heating System	16
Starting a heating circuit and DHW heating	16
Shutting down a heating circuit and stopping DHW heating	17
Starting DHW heating only	17
Stopping DHW heating	17
Adjusting the Room Temperature	
Setting a Permanent Room Temperature	18
Selecting normal room temperature	18
Selecting a reduced room temperature	19
Selecting a time program (switching times)	20
Changing the room temperature for a few days only ...	21
Selecting the holiday program	22
Changing the Room Temperature for a Few Hours Only	23
Selecting energy saving mode	23
Selecting party mode	24
Selecting DHW Heating	
Selecting Constant DHW Heating	25
DHW temperature setting	25
Selecting a time program (switching times)	26
Selecting automatic mode (if required)	26
Setting up an individual time program	27
Selecting DHW Heating for a Few Hours Only	29
Selecting DHW heating only once	30
Further Adjustments	
Time and Date	31
Language	31
Adjusting the display contrast	31
Standard setting	31
Scanning Options	
Scanning Information	32
Order in which temperatures and operating conditions can be scanned	32
Scanning Time Programs	33
Central heating time program	33
DHW time program	33
Scanning fault display	34

Table of Contents

Other Settings

Changing the Heating Pattern of the Boiler	35
Rooms are too cold	35
Rooms are too hot	35
There is no hot water	36
The DHW is too hot	36
"Select htg. circuit" flashes in the display	36
"Fault" flashes in the display	36
The time flashes in the display	36
"Service" is displayed	36
"Remote control" is displayed	37
"Ext. control" is displayed	37
"Ext. program" is displayed	37
"Ext, room t. setpt." is displayed	37
"Without function." is displayed	37

Service Instructions

Service Instructions for Your Heating System	38
---	----

How to Save Energy

How to Save Energy	39
... by heating correctly	39
... with regular maintenance	39
... with effective insulation	39

Additional Information

Lighting and Operating Instructions	40
--	----

About these Instructions

 Take note of all symbols and notations intended to draw attention to potential hazards or important product information. These include "WARNING", "CAUTION", and "IMPORTANT". See below.

 **WARNING**

Indicates an imminently hazardous situation which, if not avoided, could result in death, serious injury or substantial product/property damage.

→ *Warnings draw your attention to the presence of potential hazards or important product information.*

 **CAUTION**

Indicates an imminently hazardous situation which, if not avoided, may result in minor injury or product/property damage.

→ *Cautions draw your attention to the presence of potential hazards or important product information.*

IMPORTANT

→ *Helpful hints for installation, operation or maintenance which pertain to the product.*



→ *This symbol indicates that additional, pertinent information is to be found in column three.*



→ *This symbol indicates that other instructions must be referenced.*

For your Safety

■ Operation

Before operating the boiler, make sure you fully understand its method of operation. Your heating contractor should always perform the initial start-up and explain the system. Any warranty is null and void if these instructions are not followed.

■ Flue gas smell

- Deactivate heating equipment.
- Open windows and doors.
- Inform your heating contractor.

■ Working on the equipment

All personnel working on the equipment or the heating system must have the **proper qualifications** and hold all necessary licenses.

Ensure **main power** to equipment, heating system, and all external controls has been **deactivated**. **Close main gas supply valve**. Take precautions in all instances to avoid accidental activation of power during service work.

■ Dangerous conditions

- Deactivate main power immediately.
- Close gas supply valve.

■ Maintenance and cleaning

Regular inspection and service by a qualified heating contractor is important to the performance of the Viessmann Vitodens 200-W. Neglected maintenance impacts on warranty; regular inspection ensures clean, environmentally friendly and efficient operation. We recommend a maintenance contract with a qualified heating contractor.

■ Technical information

Literature applicable to all aspects of the Vitodens 200-W:

- Technical Data Manual
 - Installation Instructions
 - Start-up/Service Instructions
 - Operating Instructions and User's Information Manual
- Additional applicable literature:*
- Accessory manuals

For your Safety *(continued)*

■ Carbon monoxide

The U.S. Consumer Product Safety Commission strongly recommends the installation of carbon monoxide detectors in buildings in which gas-burning equipment is installed. Carbon monoxide (CO) is a colorless, odorless gas, which may be produced during incomplete combustion of fuel and/or when the flame does not receive an adequate supply of combustion air.

Carbon monoxide can cause severe personal injury or loss of life.

Therefore, carbon monoxide detectors that are in compliance with a nationally recognized standard (e.g. ANSI/UL 2034-2002, CSA 6.19-01) should be installed and maintained in buildings that contain gas-burning equipment.

Note:

Viessmann does not test any detectors and makes no representation regarding any brand or type of detector.

■ For safe operation

We recommend that you frequently:

- Check for debris which could obstruct the flow of flue gases. The vent or chimney must not be blocked. A blocked or partially blocked vent or chimney can cause flue gases to leak into the structure. Flue gases leaking into the house can cause injury or death. Blocked or partially blocked chimneys must have the blockage removed by a qualified heating contractor.
- Check pressure gage for correct system (water) pressure. Check for water on the floor from the discharge pipe of the pressure relief valve or any other pipe, pipe joint, valve or air vent.
- Check for moisture, water, or appearance of rust on the flue gas pipes, their joints as well as vent dampers, or side wall vent terminals (if so equipped).
- Ensure that nothing is obstructing the flow of combustion and ventilation air and no chemicals, garbage, gasoline, combustible materials, flammable vapors and liquids are stored (not even temporarily) in the vicinity of the boiler.
- Do **not** allow unsupervised children near the boiler.

Service/inspection of the boiler and the system is recommended once a year. Maintenance, service and cleaning are specified in the Installation Instructions.

Before the heating season begins, it is recommended that the boiler and burner be serviced by a qualified heating contractor. Service contracts may be established through gas suppliers or other licensed contractors in your area.



WARNING

As there are no user-serviceable parts on the boiler, burner or control, the end-user must not perform service activities or adjustments of any kind on system components. Failure to heed this warning can cause property damage, severe personal injury, or loss of life.



WARNING

Improper installation, adjustment, service, or maintenance can cause flue products to flow into living space. Flue products contain poisonous carbon monoxide gas which can cause nausea or asphyxiation resulting in severe personal injury or loss of life.



CAUTION

Should overheating occur or the gas supply fail to shut off, do not disconnect the electrical supply to the pump. Instead, shut off the gas supply at a location external to the appliance.



WARNING

The operator/ultimate owner is required to have the heating boiler, burners, and controls checked, as a minimum once per year, by the original installer or by a competent heating contractor familiar with the equipment. Defects must be corrected immediately.



CAUTION

Do not use this boiler if any part has been under water. Immediately call a qualified heating contractor to inspect the boiler and to replace any part of the control system and any gas control which has been under water.

For your Safety *(continued)*

Frozen water pipe hazard

 WARNING
<p>Failure to protect against frozen pipes could result in burst water pipes, serious property damage and/or personal injury. Boiler may shut down. Do not leave your home unattended for long periods of time during freezing weather conditions without turning off the water supply and draining water pipes or otherwise protecting against the risk of frozen pipes.</p>

Your heating boiler is designed to provide a warm and comfortable living environment. It is **not** designed to ensure against freezing of water pipes. The boiler is equipped with several safety devices that are designed to shut down the boiler and to prevent it from restarting in the event of various unsafe conditions.

If your boiler remains off for an extended period of time during cold weather, water pipes may freeze and burst, resulting in extensive water damage and conditions in which mold could grow. Certain molds are known to cause respiratory problems, as well as to pose other serious health risks. In case of water damage, immediate measures should be taken to dry out affected areas as quickly as possible to prevent mold from developing.

If your home will be unattended for an extended period of time during cold weather, you should...

- Shut off the water supply to the building, drain the water pipes and add an antifreeze for potable water to drain traps and toilet tanks. Open faucets where appropriate.

Or..

- Have someone check the building frequently during cold weather and call a qualified service agency if required.

Or...

- Install a reliable remote temperature sensor that will notify somebody of freezing conditions within the home.

For your Safety *(continued)*

If you notice fire coming from the appliance, call the fire department immediately! Do not attempt to extinguish the fire unless qualified to do so.



WARNING

Fire causes a risk of burns and explosion!

- Shut down the boiler
- Close fuel shut-off valves
- Use a tested fire extinguisher, class ABC.

Installation area conditions



WARNING

Incorrect ambient conditions can lead to damage to the heating system and put safe operation at risk.

- Ensure ambient temperatures are higher than 32°F / 0°C and lower than 104°F / 40°C.
- Prevent the air from becoming contaminated by halogenated hydrocarbons (e.g. as contained in paint solvents or cleaning fluids) and excessive dust (e.g. through grinding or polishing work).
Combustion air for the heating process, and ventilation of the boiler room must be free of corrosive contaminants. To that end, any boiler must be installed in an area that has no chemical exposure. The list to the right indicates the main, currently known sources.
- Avoid continuously high levels of humidity (e.g. through frequent drying of laundry).
- Never close existing ventilation openings.

Replacement components, spare and wear parts

IMPORTANT

Components which are not tested with the heating system may damage the heating system, or affect its functions. Installation or replacement may only be carried out by a qualified heating contractor.

Sources of combustion and ventilation air contaminants

Areas likely to contain contaminants:

- New building construction
- Swimming pools
- Remodelling areas, hobby rooms
- Garages with workshops
- Furniture refinishing areas
- Dry cleaning/laundry areas and establishments
- Auto body shops
- Refrigeration repair shops
- Metal fabrication plants
- Plastic manufacturing plants
- Photo processing plants
- Beauty salons

Products containing contaminants:

- Chlorine-type bleaches, detergents and cleaning solvents found in household laundry rooms
- Paint and varnish removers
- Hydrochloric acid, muriatic acid
- Chlorine-based swimming pool chemicals
- Spray cans containing chlorofluorocarbons
- Chlorinated waxes and cleaners
- Cements and glues
- Refrigerant leaks
- Calcium chloride used for thawing
- Sodium chloride used for water softening salt
- Permanent wave solutions
- Adhesives used to fasten building products and other similar items
- Antistatic fabric softeners used in clothes dryers

Getting Started...

The timer of the control unit switches between "normal room temperature" and "reduced room temperature" at the required times.

1. Normal room temperature

for the times you spend at home and require a comfortably warm room temperature (e.g. 68°F / 20°C).

→ *Times and duration of the two room temperatures can be set on the programming unit of your control. The temperature settings for both the "normal room temperature" and "reduced room temperature" can be set according to your personal preference.*

2. Reduced room temperature

for the times you are away from home. To save energy, a lower temperature is typically selected (e.g. 57°F / 14°C).

The timer of the control unit switches domestic hot water production on and off at the required times.

1. Domestic hot water heating can be set to take place

during the times you spend at home and require hot water for your daily DHW requirements (e.g. for showering).

→ *Times and duration of the domestic hot water production period can be set on the programming unit of your control.*

You may select a DHW temperature setting based on your personal preference of up to 140°F / 60°C.

2. Domestic hot water heating can be set not to take place

for the times you spend sleeping, for example.

The domestic hot water recirculation pump (if installed) ensures that domestic hot water is readily available when domestic hot water is drawn.

Your Vitodens 200-W Boiler

Please ask your heating contractor to check off the appropriate box (☒).

**Vitodens 200-W
without domestic hot water tank**

The control unit activates and deactivates space heating and supplies rooms with heat.

**Vitodens 200-W
with separate domestic hot water tank**

Domestic hot water heating has priority over space heating. The control unit switches automatically to space heating when the preset domestic hot water temperature is reached.

Your System is Preset at the Factory

The control unit is preset at the factory for standard operation. Your heating system is therefore ready to use:

- Between **06:00 and 22:00 hrs.** the system provides central heating with standard room temperature.
- DHW will be heated between **05:30 and 22:00 hrs.** DHW will be heated to the set temperature subject to a DHW tank being installed. The DHW circulation pump is switched ON (if connected to the control unit).
- Between **22:00 and 06:00 hrs.** the system provides central heating with the reduced room temperature (set to 3°C, frost protection).
- Between **22:00 and 05:30 hrs.** the DHW tank temperature will not be boosted. The DHW circulation pump is switched OFF (if connected to the control unit).
- The system automatically changes over between **summer and winter time.**

You may change the factory settings in accordance with personal requirements.

Note:

All data is saved in case of power failure.

→ *Press button "⌘" to reset the switching times to their factory default settings.
Please note that this will reset all altered values to their original factory default setting.*

Overview of Controls and Indicators

You can change all settings for your heating system, centrally, at the control unit. You may also make such adjustments for the respective heating circuits at the remote control unit, if your system is equipped with such a unit.



See the remote control operating instructions.

Opening the control unit

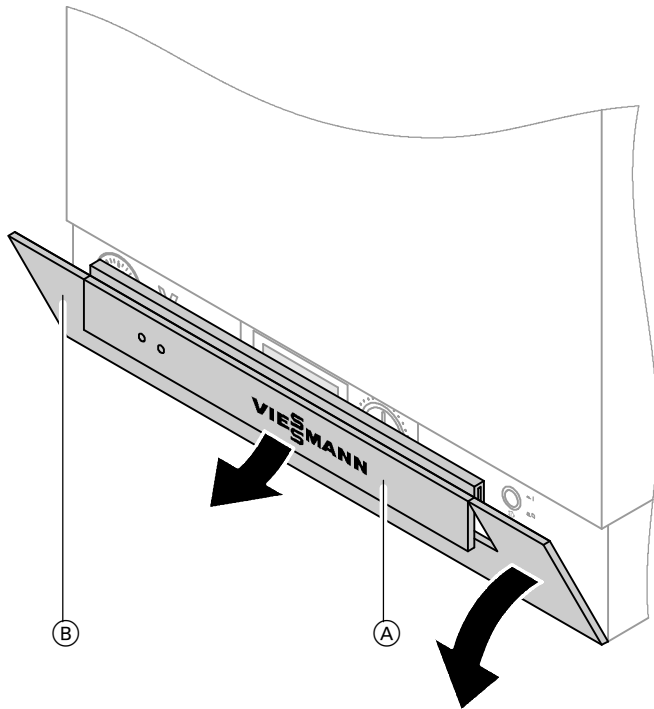

Lift cover (A) and pivot control unit flap (B) down. All boiler controls are located behind the control unit flap.

- (A) Cover
- (B) Control unit flap (open to make adjustments)

Overview of Controls and Indicators *(continued)*

Vitotronic 200 Type HO1 Functions

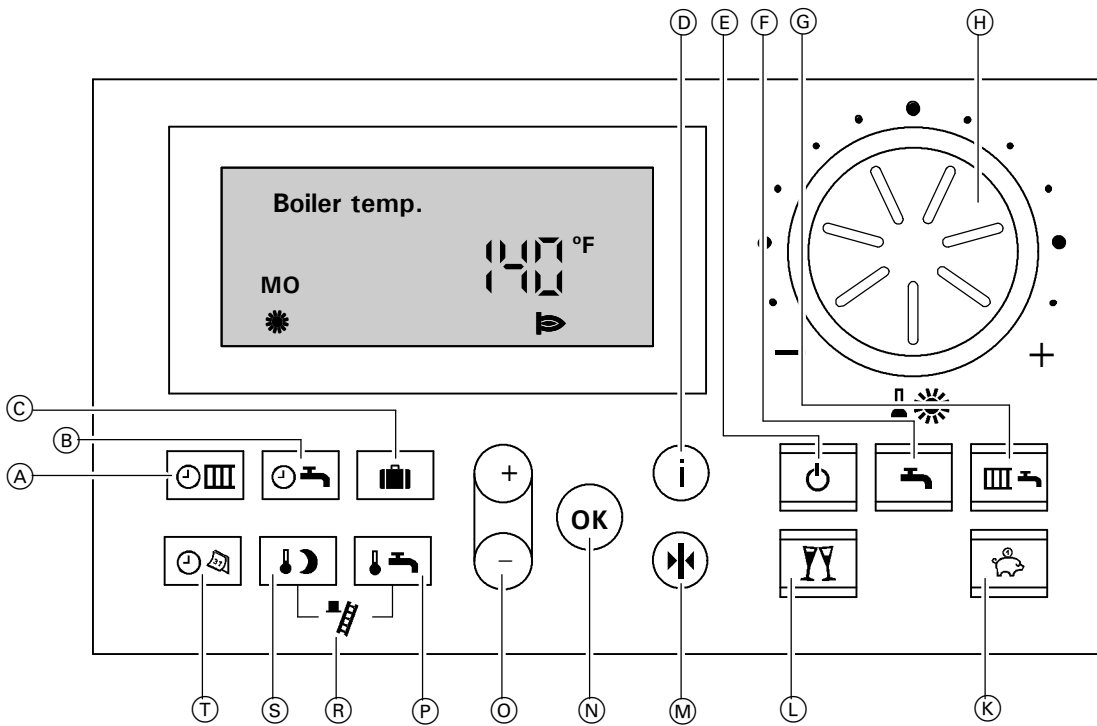

- | | |
|------------------------------------|---|
| Ⓐ Time program for central heating | Ⓛ Party mode ON / OFF |
| Ⓑ Time program for DHW heating | Ⓜ Factory default settings button |
| Ⓒ Holiday program | Ⓝ Confirmation button |
| Ⓓ Information | Ⓞ Adjustment buttons |
| Ⓔ Standby mode | Ⓟ DHW temperature |
| Ⓕ DHW only | Ⓡ Emission test function (only for heating engineers) |
| Ⓖ Central heating and DHW | Ⓢ Reduced room temperature |
| Ⓗ Normal room temperature | Ⓣ Time / date |
| Ⓚ Energy saving mode ON / OFF | |

Overview of Controls and Indicators *(continued)*

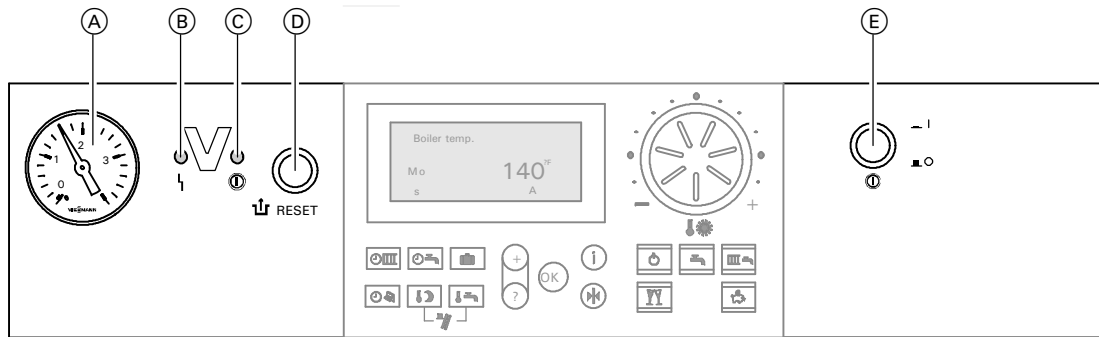

- (A) Pressure gauge
- (B) Fault display (red)
- (C) Operating status display (green)
- (D) Reset button
- (E) ON / OFF switch

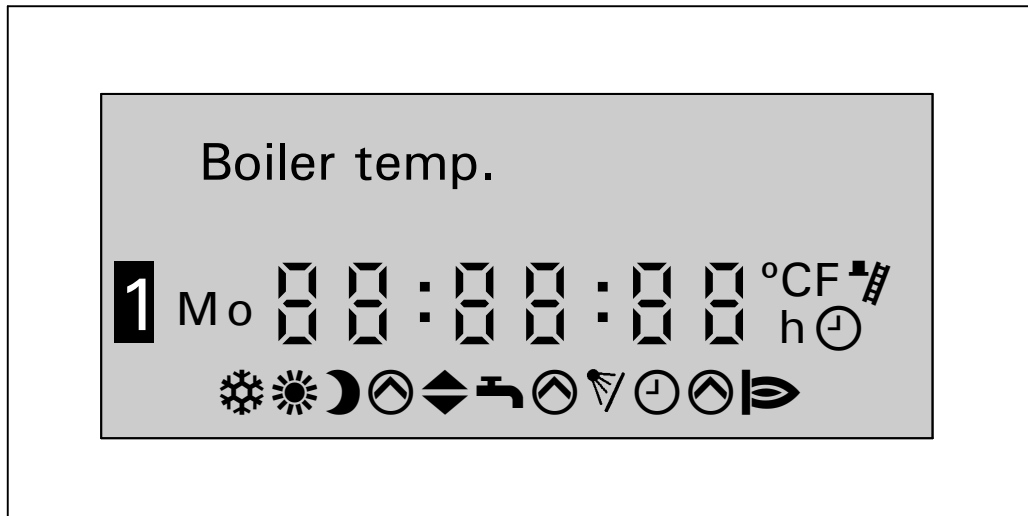

These symbols are not always displayed, but appear subject to the system version and the operating state.

- Risk of freezing
- Central heating with normal room temperature
- Central heating with reduced room temperature
- Heating circuit pump ON
- Mixing valve "OPEN"
- Mixing valve "CLOSED"
- DHW heating enabled
- DHW pump ON
- DHW heating via solar heating system (accessories)
- Burner ON
- Time adjustment display
- Emissions test ON
- Burner fault (appears instead of the day of the week)
- In case of two heating circuits: Selected heating circuit

Overview of Controls and Indicators *(continued)*

Heating system with two heating circuits

When two heating circuits have been connected to your heating system, select the heating circuit to which the setting should apply before making adjustments at the control unit.

Press the following keys:

1. ⊕ "1" flashes on the display.

2. OK for selecting heating circuit A1 (heating circuit without mixing valve).

Or..

3. ⊕ for heating circuit M2 (heating circuit with mixing valve) "2" flashes on the display.

4. OK for selecting heating circuit M2 (heating circuit mixing valve).

5. Continue with the required adjustment (e.g. activate rotary selector "🔧" or press the appropriate key for the relevant function).

Note:

"Select heating circuit" will be displayed should you begin making adjustments prior to selecting the relevant heating circuit.

Note:

After approximately 4 seconds or if you press OK again, the following will be displayed:

The figure in front of the day indicates which heating circuit has been selected.

Note:

If "Remote control" flashes in the display, make the relevant adjustment at the remote control.



See the remote control operating instructions.

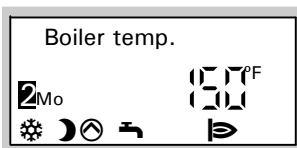

Starting the Heating System

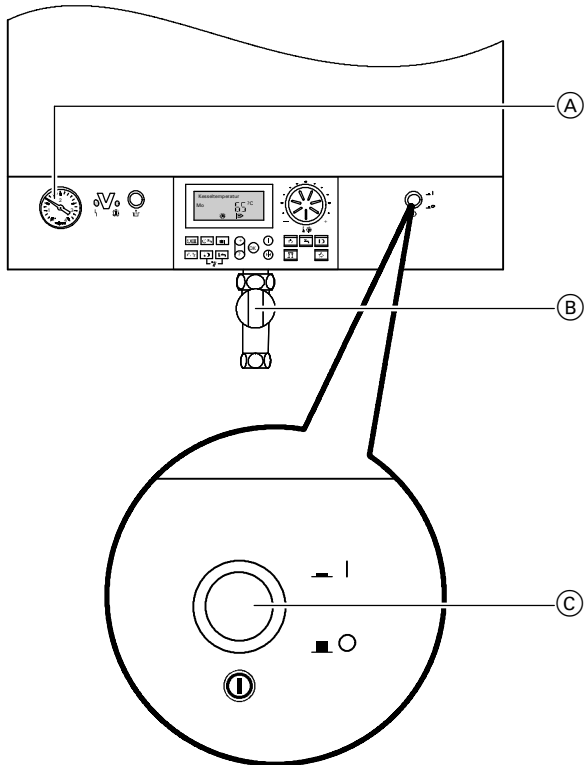

1. Check the pressure of the heating system on the pressure gauge (A): If the pressure is below 12 psi / 0.8 bar the system pressure is too low. Notify your heating contractor if the system pressure is too low.

2. For room air dependent operation: Check whether the ventilation apertures in the boiler room are open and unobstructed.

Note:

For room air dependent operation: This boiler requires fresh air for safe operation. The boiler must be vented and supplied with air and exhaust vents.

3. Open gas shut-off valve (B).

4. Switch ON the power supply, (e.g. at the breaker or electrical disconnect switch. Energize power / pump module).

5. Switch ON the heating system ON / OFF switch "I" (C); the operating status is indicated (ON indicator) by the green LED and the boiler water temperature will appear in the display.

Shutting Down the Heating System

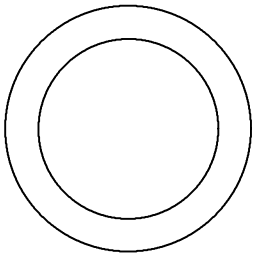

If you do not want to use your heating system temporarily, (e.g. during your summer holidays), switch to stand-by operation (see "Shutting down a heating circuit and stopping DHW heating").

Note:

The circulation pumps are briefly started every 24 hours to prevent them from seizing up.

If you do not want to use your heating system for a long period (several months), you should shut down the system.

We advise you to contact your heating contractor before shutting down the heating system for long periods. Your heating contractor will take any necessary action, (e.g. for frost protection of the system or to safeguard the heat exchanger surfaces).

1. Switch the main ON / OFF switch "ⓘ" OFF.
2. Close the gas shut-off valve.
3. Turn off the power supply switch or disconnect power / pump module. The power supply to the system is now switched off. There is no frost protection.

Note:

All control settings are retained.

Starting a heating circuit and DHW heating

You want to heat your rooms and have DHW available.

Press "☰☛" for "Heating & DHW".

If "Select heating circuit" is displayed and "1☰" flashes:

- Select that heating circuit with ⊕ / ⊖, to which the adjustment should apply.
- Confirm twice with Ⓞ.

Press "☰☛" for "Heating & DHW" again.

- Central heating will be provided with normal or reduced room temperature (frost protection) according to the set time program. Standard setting: from 06:00 to 22:00 hrs. with the normal room temperature, otherwise with the reduced room temperature.
- DHW heating (if a DHW tank or instantaneous water heater is installed) and DHW circulation pump running (if connected to the control unit) according to the selected time program. Standard setting: from 05:30 to 22:00 hrs., DHW is heated to the selected set temperature and the DHW circulation pump is switched ON.
- Frost protection for the boiler and the DHW tank is enabled.

Note:

"☰☛" button illuminates:

- Symbol "☀" appears during central heating with normal room temperature.
- Symbol "☾" appears during central heating with a reduced room temperature above 37°F / 3°C.

Shutting Down the Heating System *(continued)*

Shutting down a heating circuit and stopping DHW heating

You do not want to heat your rooms or have DHW available.

Press "⏻" for "Standby mode".

If "Select heating circuit" is displayed and "1 IIII" flashes:

- Select the heating circuit with ⊕ / ⊖, to which the adjustment should apply.
- Confirm twice with .
- Press "⏻" again for "Standby mode".

Standby mode:

- Central heating is disabled for the selected heating circuit.
- No DHW heating.
- Frost protection for the boiler and the DHW tank is enabled.

Note:

The circulation pump is briefly started every 24 hours to prevent it from seizing up.

Starting DHW heating only

You do not want to heat your rooms but have DHW available.

Press "🔥" for "DHW only".

If "Select heating circuit" is displayed and "1 IIII" flashes:

- Select the heating circuit with ⊕ / ⊖, to which the adjustment should apply.
 - Confirm twice with .
- Press "🔥" for "DHW only" again.

- Central heating is disabled for the selected heating circuit.
- DHW heating (if a DHW tank is installed) and DHW circulation pump (if connected to the control unit) ON according to the set time program. Standard setting: from 05:30 to 22:00 hrs., DHW is heated to the selected set temperature and the DHW circulation pump is switched ON.
- Frost protection for the boiler and the DHW tank is enabled.

Note:

If "🔥" is illuminated and DHW heating is enabled in accordance with the selected time program, then "🔥" will be displayed.

Stopping DHW heating

You want to heat your rooms but not make DHW available. Set the DHW temperature to 50°F / 10°C (see page 25).

Setting a Permanent Room Temperature

Observe the following points if your heating circuit should provide central heating.

- "Heating & DHW" "☀️" must be illuminated, otherwise press "☀️".

If "Select heating circuit" is displayed and "1" flashes:

- Select the heating circuit with ⊕ / ⊖, to which the central heating should apply.
- Confirm twice with OK.
- If "☀️" does not illuminate, press "☀️" again.

- You can select the normal room temperature "☀️" (for day) and the reduced room temperature (for night) with "🌙".

- The timing of when your heating circuit operates to provide central heating with normal or reduced room temperature depends on the settings of the time program (see page 20).
 - If no time phases are selected, central heating will be enabled for the whole day at reduced room temperature.
 - If one or more time phases are selected, central heating will be enabled for those times with normal room temperature.

You can scan the time program, (see page 33).

For changing the time program, (see page 20).

Selecting normal room temperature

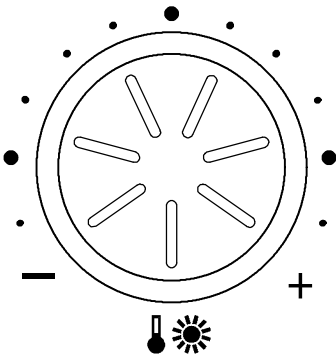

Select the required temperature for the "Normal room temp." with selector dial "☀️".

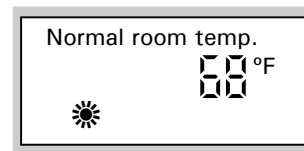

If "Select htg. circuit" is displayed and "1" flashes:

- Select the heating circuit with ⊕ / ⊖, to which the central heating should apply.
- Confirm twice with OK.
- Set the required temperature for "Normal room temp." with selector dial "☀️".



Setting a Permanent Room Temperature *(continued)*

Selecting a reduced room temperature

Press the following buttons:

1.  for "Red. room temp.", the current temperature will flash.

If "Select htg. circuit" is displayed and "1 III" flashes:

- Select the heating circuit with \oplus / \ominus , to which the central heating should apply.
- Confirm twice with .
-  again for the "Red. room temp.", the current temperature selection will flash.

Note:

When setting the reduced room temperature to 37°F / 3°C, "Frost protection" will be displayed.

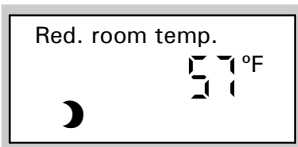

2. \oplus/\ominus for the required temperature.

If "Select htg. circuit" is displayed and "1 III" flashes:

3.  to confirm; the temperature no longer flashes and is saved.

4.  to exit the setting menu.

Setting a Permanent Room Temperature *(continued)*

Selecting a time program (switching times)

For central heating, up to four changes can be made between normal and reduced room temperature (four time phases). At the factory, time phase 1 is set for every day from 06:00 to 22:00 hrs., ie. during that time, all rooms are heated to the normal room temperature. You can set the time programs the same for every day or for each day of the week individually.

When setting time programs, bear in mind that your heating system requires some time to heat the rooms to the required temperature.

For a sequence of steps to delete a time phase, (see page 21).

Steps for selecting a time program:

Press the following keys:

1. \ominus III for "Htg. time program".

If "Select htg. circuit" is displayed and "1 III " flashes:

- Select the heating circuit with \oplus / \ominus , to which the central heating should apply.
- Confirm twice with OK .
- " \ominus III " again for the "Heating time program".

Note:

If you want to terminate the time programming early, press " \ominus III " again and confirm with OK .

Central heating time prog.

1-7

2. \oplus/\ominus until "1-7" is displayed, if you want to set up identical time phases for every day.

Or..

3. \oplus/\ominus until "Mo", "Tu" etc. is displayed, if you want to set up different time phases for the day displayed.

Note:

If different time phases are set for individual days and you want to return to identical time phases for every day, press OK when "1-7" is displayed. All time phases are returned to their original condition.

4. OK to confirm; "Htg. timer 1" will then be displayed.

5. OK to confirm; "Htg. cycle 1 On" will then be displayed.

Note:

Press OK if you want to skip a time phase.

6. \oplus/\ominus for the heating phase starting point.

7. OK to confirm; "Htg. cycle 1 Off" will then be displayed.

8. \oplus/\ominus for the heating phase end point.

9. OK to confirm; "Htg. cycle 2 On" will then be displayed.

10. Proceed for adjusting the start and end of heating phases 2 to 4 as described under steps 6 to 8.

Central heating time prog.

Mo

Setting a Permanent Room Temperature *(continued)*

Selecting a time program (switching times) *(continued)*

Press the following buttons if you want to delete a time phase:

1. for "Htg. time program".

If "Select htg. circuit" is displayed and "1 flashes:

- Select the heating circuit with \oplus / \ominus , to which the central heating should apply.
- Confirm twice with .
- " " again for the "Heating time program".

2. until the required "Htg. cycle 1 Off" is displayed.
3. \oplus/\ominus until " - - : - - " is displayed for the end time.
4. to confirm; until the boiler water temperature is displayed.

Heating phase 2 OFF

1-7 - - : - -

Changing the room temperature for a few days only

The following energy saving options are available for times, when you are not at home:

- You can completely shut down central heating by pressing (standby mode).

Or..

- You can set the central heating to minimum energy consumption (e.g. to prevent house-plants from suffering through cold). For this, select the "Holiday program" .

During the holiday program, all heating circuits are heated with the selected "Red. room temp.", but there will be no DHW heating.

Setting a Permanent Room Temperature *(continued)*

Selecting the holiday program

The selected time program will be enabled at the departure and return days.

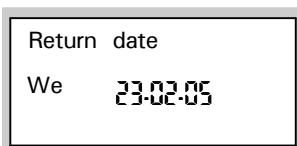



Press the following keys:

1.  for "Holiday program".

Or..

2.  for "Departure date" (the current date is displayed).

3.  for the date of the required departure day.

4.  to confirm; "Return date" (a date following that of the departure day) will be displayed.

5.  for the date of the required return day.



6.  to confirm.

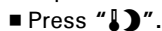

7. The room temperature during the holiday program is the selected reduced room temperature (see page 19).

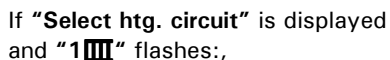
If you want to change this temperature:

- Press ".

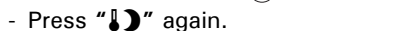
If "Select htg. circuit" is displayed and "1 

- Select the heating circuit with  / , to which the central heating should apply.
- Confirm twice with .
- Press "

- Select the required value with  / .
- Press  to confirm; the temperature no longer flashes and is now saved.



Note:

After approximately 4 sec. "Departure date" will be displayed. Press  again if you want to terminate setting a holiday program early.

Note:



This change generally applies to the reduced room temperature and must be modified again, if required, after the holiday program ends.

Ending holiday program:

- The holiday program terminates automatically on the day of return.
- Press  again if you want to terminate the holiday program early and confirm "Delete? Yes" with .

Changing the Room Temperature for a Few Hours Only

The following functions enable you to change your room temperature for several hours, without permanently altering your control settings.

- You want to leave your home and, according to the time program, central heating with normal room temperature is currently selected. To save energy, you can reduce the normal room temperature with **"Energy saving mode"** .
- You want to heat spontaneously with the normal room temperature and provide DHW (e.g. when guests unexpectedly stay longer in the evening). For this, select **"Party mode"**  (see page 24).



Selecting energy saving mode

In energy saving mode, the normal room temperature will be reduced automatically. Energy saving mode ends automatically with the next change to central heating with **"Red. room temp."**

Economy mode

1.  for **"Energy saving mode"**.



If **"Select htg. circuit"** is displayed and **"1 IIII"** flashes:

- Select the heating circuit with \oplus / \ominus , to which the adjustment should apply.
- Confirm twice with .
-  again for **"Energy saving mode"**.

2. **Ending energy saving mode**

If you want to terminate energy saving mode early, press .

If **"Select htg. circuit"** is displayed and **"1 IIII"** flashes:

- Select the heating circuit with \oplus / \ominus , to which the adjustment should apply.
- Confirm twice with .
- Press  again.

Changing the Room Temperature for a Few Hours Only *(continued)*

Selecting party mode

- Central heating will be enabled at any temperature you select (party temperature).
- The DHW will be boosted to the set temperature.
- The DHW circulation pump is switched ON (if installed).

Press the following keys:

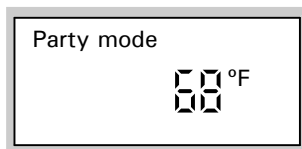

1. **Y** for **"Party mode"**; the value of the party temperature flashes.

If **"Select htg. circuit"**; is displayed and **"1 IIII"** flashes:

- Select the heating circuit with \oplus / \ominus , to which the adjustment should apply.
 - Confirm twice with **OK**.
 - **"Y"** again for **"Party mode"**; the party temperature flashes.
2. \oplus / \ominus for the required temperature, if you want to change the room temperature.
 3. **OK** to confirm; the temperature no longer flashes and is saved.
 4. **OK** to exit the setting menu.

5. Ending party mode

- Party mode ends automatically with the next changeover to central heating with normal room temperature, but no later than after 8 hours.
- If you want to terminate party mode early, press **"Y"** again.

If **"Select htg. circuit"** is displayed and **"1 IIII"** flashes;

- Select the heating circuit with \oplus / \ominus , to which the adjustment should apply.
- Confirm twice with **OK**.
- Press **"Y"** again.

Selecting Constant DHW Heating

Observe the following points if you want to enable DHW heating:

1. Set "Htg. + DHW" "III" or "DHW only" "II" for the selected heating circuit.

Check:

"III" or "II" must be illuminated, otherwise press "III" or "II".

If "Select htg. circuit" is displayed and "1 III" flashes:

- Select the heating circuit with ⊕ / ⊖, to which the adjustment should apply.
- Confirm twice with OK.
- "III" or "II" must be illuminated, otherwise press "III" or "II".

Note:

You can adjust the DHW temperature. See "DHW temperature setting" section.

2. The timing of when DHW heating is enabled and when the DHW circulation pump runs, depends on the settings of the time program). You can scan the time programs (see page 33).

Note:

For changing the time program, (see page 26).

DHW temperature setting

Press the following keys:

1. ↓ for "DHW temp. setpt."; the current temperature will flash.
2. ⊕/⊖ for the required temperature.
3. OK to confirm; the temperature no longer flashes and is saved.

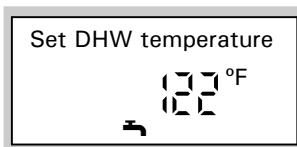

Selecting Constant DHW Heating *(continued)*

Selecting a time program (switching times)

Heating system without DHW recirculation pump

DHW can be enabled / disabled up to four times per day (four time phases).

Automatic mode is set in the time program in the factory. That means DHW heating is enabled in parallel to the central heating program of the **first available** heating circuit, but starts 30 min. earlier (from 05:30 to 22:00 hrs.).

Should you not wish to operate in automatic mode, you can also set up **individual time programs**. You can select **identical** time programs for every day or **individual** programs for each day.

When setting time programs, bear in mind that your heating system requires some time to heat the DHW tank to the required temperature.

For time programming steps, (see pages 26 and 27). For a sequence of steps to delete a time phase, (see page 28).

Heating system with DHW recirculation pump

The DHW recirculation pump transports hot water through a circuit between the DHW tank and the draw-off points to deliver DHW to the taps as quickly as possible.

DHW heating and the DHW recirculation pump can be enabled / disabled up to four times per day (four time phases).

Automatic mode is set in the time program at the factory. That means DHW heating and the DHW recirculation pump are activated in parallel to the central heating program of the **first available** heating circuit, but starts 30 min. earlier (from 05:30 to 22:00 hrs.).

Should you not wish to operate in automatic mode, you can also set up **individual time programs**. You can select **identical** time programs for every day or **individual** programs for each day.









When setting time programs, bear in mind that your heating system requires some time to heat the DHW tank to the required temperature.

Also, enabling the DHW recirculation pump is only sensible for those times when DHW is actually drawn.

For time programming steps, (see pages 26 and 27). For a sequence of steps to delete a time phase, (see page 28).

Selecting automatic mode (if required)

Press the following keys:

1.   for "DHW time program".
2.  /  to select "DHW time program", or "Recirc. pump time program".
3.  to confirm.
4.  /  for "Automatic?", if "Automatic?" is not yet displayed.
5.  to confirm.

Selecting Constant DHW Heating *(continued)*

Setting up an individual time program

The following explains the setting up of a time program using DHW heating “⊕🔌” as an example. For the DHW recirculation pump time program, proceed as described above, after you have selected “**Recirc. pump time program**”.

Press the following keys:

1. ⊕🔌 for “**DHW time program.**”.

Note:

If you want to terminate the time programming **early**, press “⊕🔌” again and confirm with (OK).

2. ⊕/⊖ to select “**DHW time program.**”, or “**Recirc. pump time program.**”.
3. (OK) to confirm.
4. ⊕/⊖ for “**Individual?**”, if Individual? is not yet displayed.
5. (OK) to confirm.
6. ⊕/⊖ until “**1-7**” is displayed, if you want to set up the same time phases for every day.

Or..

7. ⊕/⊖ until “**Mo**”, “**Tu**” etc. is displayed, if you want to set different time phases for the displayed day.
8. (OK) to confirm; “**DHW timer 1**” will then be displayed.
9. (OK) to confirm; “**DHW timer 1 ON**” will then be displayed.
10. ⊕/⊖ for DHW phase starting point.
11. (OK) to confirm; “**DHW cycle 1 Off**” will be displayed.
12. ⊕/⊖ for DHW phase end point.
13. (OK) to confirm; “**DHW cycle 2 On**” will then be displayed.
14. Proceed for setting the start and end of DHW phases 2 to 4 as described in steps 9 to 11.

Note:

If different time phases are set for individual days and you want to return to identical time phases for every day, press (OK) when “**1-7**” is displayed. All time phases are returned to their original delivered condition.

Note:

Press ⊕ if you want to skip a time phase.

DHW time prog.
1-7

DHW time prog.
Mo





Selecting Constant DHW Heating *(continued)*

Setting up an individual time program *(continued)*

DHW phase 2 OFF

1-7 - - : - -

Press the following keys if you want to delete a time phase:

1.   for "DHW time program".
2.  until the required "DHW phase Off" is displayed.
3.  until "- - : - -" is displayed for the end time.
4.  to confirm; until the boiler water temperature is displayed.

Selecting DHW Heating for a Few Hours Only

The following functions enable you to heat DHW for several hours, without permanently altering your control settings. For this, select **"Party mode"** "YY". During party mode, the DHW recirculation pump is active and central heating operates with the party temperature. Set the party temperature to 39.2°F / 4°C, if you require no central heating (e.g. in summer).

Press the following keys:

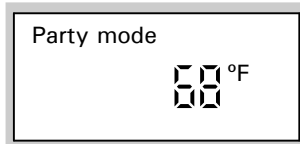

1. YY for **"Party mode"**; the value of the party temperature flashes.

If **"Select htg. circuit"** is displayed and "1 III" flashes:

- Select that heating circuit with ⊕ / ⊖, to which the adjustment should apply.
- Confirm twice with OK.
- "YY" again for **"Party mode"**; the party temperature flashes.

2. ⊕/⊖ for the required temperature, if you want to change the room temperature.

3. OK to confirm; the temperature no longer flashes and is saved.

4. OK to exit the setting menu.

5. Ending party mode

- Party mode ends automatically with the next changeover to central heating with normal room temperature, but no later than after 8 hours.
- If you want to terminate party mode early, press "YY" again.

If **"Select htg. circuit"** is displayed and "1 III" flashes:

- Select that heating circuit with ⊕ / ⊖, to which the adjustment should apply.
- Confirm twice with OK.
- Press "YY" again

Selecting DHW Heating for a Few Hours Only *(continued)*

Selecting DHW heating only once

The following function enables you to heat DHW once, without permanently altering your settings. For this, select **"Party mode"** "YY".

The following function enables you to heat DHW once, without permanently altering your settings. For this, select **"Party mode"** "YY".

Precondition:

- Not in **"Standby mode"** "⏻" and not in the **"Holiday program"** "■".
- The DHW temperature must be below the set value.

Press the following keys:

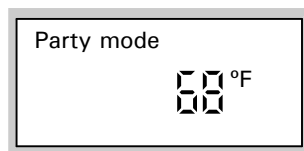

1. YY for **"Party mode"**; the value of the party temperature flashes.

If **"Select htg. circuit"**; is displayed and "1 III" flashes:

- Select that heating circuit with ⊕ / ⊖, to which the adjustment should apply.
 - Confirm twice with (OK).
 - "YY" again for **"Party mode"**; the party temperature flashes.
2. (OK) to confirm; DHW heating begins.
 3. After approximately 10 sec., press "YY" again.

Time and Date

Date and time are factory-set and may be changed manually. During commissioning, or after prolonged time out of use, it may be necessary to set the time and date.

Note:

Summer/winter time will be automatically changed over. Press the following keys:

Note:

Summer/winter time will be automatically changed over.

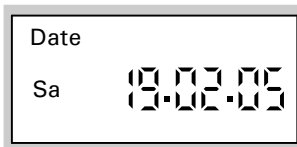

1. \rightarrow for "Time".
2. \oplus/\ominus for the required time.
3. OK to confirm; "Date" will then be displayed.
4. \oplus/\ominus for the required date.
5. OK to confirm.

Language

Press the following keys:



1. i "Outdoor temp." will be displayed.
2. \ominus for the required language.
3. OK to confirm.

Adjusting the display contrast

Open the programming unit flap. Press OK and simultaneously adjust the contrast with \oplus or \ominus .

Standard setting

All modified values are reset to their factory settings by pressing "⌘".

Scanning Information

Subject to the connected components and settings you have made, you can scan the actual temperatures and operating conditions.

Press the following keys:



1. **i** for example, “Outdoor temp.” may be displayed.

If “Select htg. circuit”; is displayed and “1 **III**” flashes:

- Select that heating circuit with ⊕ / ⊖, to which the adjustment should apply.
- Confirm twice with **OK**.
- Press **i** again.

2. ⊕/⊖ for further scanning of the list.

3. **i** to end scanning.

Order in which temperatures and operating conditions may be scanned

You can scan various current temperatures and operating status information depending on the system components and the settings.

- **Subscriber no.** - in connection with other control units
- **Holiday program** - (if entered) with dates of departure and return
- **Outdoor temperature**
- **Boiler water temperature**
- **Flow temperature** - for heating circuit with mixing valve
- **Normal room temp.** - set value
- **Room temperature** - actual value only if a remote control unit is connected
- **Ext. Set room temp.** - only if external hook-up has taken place
- **DHW temperature** - DHW temperature
- **Solar DHW temp.** - DHW temperature in solar mode (if used)
- **Collector temperature** - only if a solar heating system is connected
- **Common flow temp.** - common flow temperature for systems with low loss header
- **Burner*1** - burner hours run
- **Burner starts*1**
- **Solar energy** - display in kWh (only if a solar heating system is connected)
- **Time**
- **Date**
- **Burner ON / OFF**
- **Int. pump ON / OFF** (boiler pump)
- **Int. output ON / OFF** - for internal connection extension
- **Heating pump ON / OFF** - for external heating circuit pump for heating circuit A1 (pump 20A)
- **Tank pump ON / OFF** (pump 21)
- **C pump ON / OFF** - DHW recirculation pump (pump 28)
- **Central fault m. ON / OFF** - central fault message (output 50)
- **Mixing valve**
Mixing valve open - fully open
Mixing valve - intermediate position
Mixing valve closed - fully closed
- **Solar circuit pump ON / OFF** (not used)
- **Solar circuit pump ...hrs.** - solar circuit pump hours run (not used)
- **Language**

*1 To reset to “0”: Press **↵** and confirm with **OK**.

Scanning Time Programs

Central heating time program

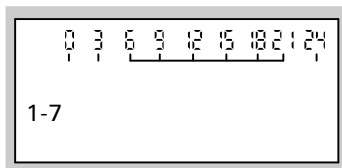

Press the following keys:

1. \ominus + \textcircled{i} press and hold down simultaneously for central heating time program; the set time phases will then be displayed on a time slot graphic.

If "Select htg. circuit" is displayed and "1 " flashes:

- Select that heating circuit with \oplus / \ominus , to which the adjustment should apply.
- Confirm twice with \textcircled{OK} .
- Again, press and hold down " \ominus + \textcircled{i} " simultaneously; a time slot graphic shows the selected time phases.

For changing the time program, (see page 26).

DHW time program

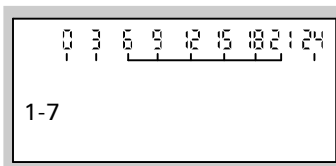

1. \ominus + \textcircled{i} press and hold down simultaneously for DHW time program; the set time phases will then be displayed on a time slot graphic.

Note:

For changing the time program, (see page 26).

Scanning Time Programs *(continued)*

Scanning fault display

If your heating system has developed a fault, it will be displayed and indicated by the flashing red fault indicator. You can read off the fault code on the display by scanning; then notify your local heating contractor accordingly. This allows your heating contractor to better prepare for the service call and may save additional travelling costs.

Fault display examples:

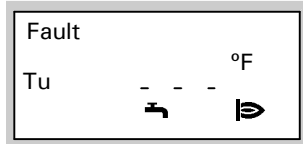

Control unit fault

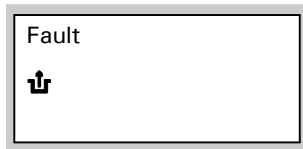

Fault on a burner component

Press the following keys:

1. in case of a fault on a burner component.

2. for troubleshooting.

Example:

In this case, notify your local heating contractor of fault (1) message "38".

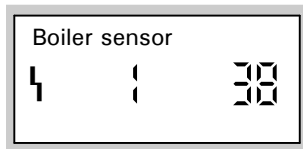

3. to "Acknowledge".

4. for "Yes" or "No".
With "Acknowledge? Yes" you confirm that you have noted the fault.

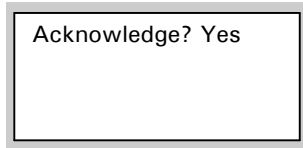

5. to confirm.

Note:

If the fault has not been rectified, the fault message will be displayed again at 07:00 hrs. the following day. The red fault indicator flashes until the fault has been rectified.

Changing the Heating Pattern of the Boiler

Rooms are too cold

Cause	Remedy
The heating system is switched OFF. ON indicator "Ⓢ" (green) OFF.	Switch system ON / OFF switch "Ⓢ" ON (see page 13). Switch ON the main breaker, if installed (outside the boiler room). Reset circuit breaker inside the power distribution panel.
Control unit or remote control incorrectly adjusted.	Check settings and correct, if required: - Room temperature - Time - Time program
Only when operating with DHW heating: DHW priority (ⓈⓈ is displayed).	Wait until the DHW tank has been heated up (Ⓢ disappears from the display).
In connection with the Vitotronic 200-H or extension kit for heating circuits with mixing valve: The ON / OFF switch on the mixing valve motor is switched OFF.	Switch ON / OFF switch on the mixing valve motor ON, I=ON.
No fuel.	With Natural Gas / LPG: Open the gas shut-off valve and check with your gas supplier, if required. Press burner fault reset "Ⓢ".
"Fault" and "Ⓢ" are displayed; the red fault indicator at the control unit flashes.	Press burner fault reset "Ⓢ" - if that fails, notify your heating contractor.
Control unit fault: "Fault" is displayed and the red fault indicator flashes.	Scan the type of fault and notify your local heating contractor.
Mixing valve motor faulty.	Unhook motor lever (A) and manually set mixing valve lever (B). Notify your local heating contractor.

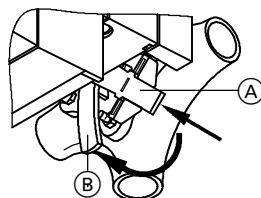

Rooms are too hot

Cause	Remedy
Control unit or remote control incorrectly adjusted.	Check settings and correct, if required: - Room temperature - Time - Time program
Control unit or outside temperature sensor faulty: "Fault" is displayed and the red fault indicator flashes.	Scan the type of fault and notify your local heating contractor.

Changing the Heating Pattern of the Boiler *(continued)*

There is no hot water

Cause	Remedy
The heating system is switched OFF. ON indicator "Ⓢ" (green) OFF.	Switch system ON / OFF switch "Ⓢ" ON. Switch ON the main breaker, if installed (outside the boiler room). Reset circuit breaker inside the power distribution panel.
Control unit or remote control incorrectly adjusted.	Check settings and correct, if required: - DHW heating must be switched ON - DHW temperature - Time program - Time
No fuel.	With Natural Gas / LPG: Open the gas shut-off valve and check with your gas supplier, if required. Press burner fault reset "⚡".
Control unit fault: "Fault" is displayed and the red fault indicator flashes.	Scan the type of fault and notify your local heating contractor.

The DHW is too hot

Cause	Remedy
Control unit incorrectly adjusted.	Check and, if required, correct DHW temperature (see page 25).

"Select htg. circuit" flashes in the display

Cause	Remedy
Control element activated without selecting a heating circuit first.	Select that heating circuit, to which the adjustment should apply

"Fault" flashes in the display

Cause	Remedy
Heating system fault.	Scan for the type of fault and notify your local heating contractor.

The time flashes in the display

Cause	Remedy
Longer heating system off periods.	Reset the time and date.

"Service" is displayed

Cause	Remedy
The heating system requires a service.	Ask your local heating contractor to service the boiler.

Changing the Heating Pattern of the Boiler *(continued)*

"Remote control" is displayed

Cause	Remedy
A remote control is connected to the heating circuit.	Make adjustments or carry out scans at the remote control (see separate operating instructions).

"Ext. control" is displayed

Cause	Remedy
The heating program set at the control unit was changed over by an external device (e.g. connection extension).	No action required. The heating program changeover was manually selected.

"Ext. program" is displayed

Cause	Remedy
The heating program set at the control unit was changed over by the Vitocom 100 communicating interface (not used).	No action required. The heating program changeover was manually selected.

"Ext. room t. setpt." is displayed

Cause	Remedy
A room set point temperature has been connected via the communication interface.	No action required. The connection was manually selected.

"Without function" is displayed

Cause	Remedy
No function is allocated to the key you have pressed.	No action required. Select appropriate key.

Service Instructions for Your Heating System

Viessmann strongly recommends inspection/service of the boiler and the system by a licensed professional heating contractor once a year.

Before the heating season begins, the boiler with its burner(s) and direct vent system should be serviced by a qualified heating contractor. Service contracts may be established through gas suppliers or other licensed contractors in your area.

Regular inspection/service ensures trouble-free, energy-efficient and environmentally friendly heating activity of your heating system.

Boiler

All boilers must be cleaned on a regular basis as debris build-up will result in increased flue gas temperature, and thus in increased energy consumption.

→ **Notes on operation:**

- *Ensure boiler room and boiler are clean.*
- *Regularly check heating system pressure on the pressure gage: If the needle of pressure gage is below 12 psig, the system pressure is too low; in this case, please contact your heating contractor.*

Domestic hot water storage tank

Inspection and (if necessary) cleaning of the tank must take place within 2 years of initial start-up and as required thereafter.

Cleaning of the inside surfaces of the DHW storage tank, including DHW connections, may only be performed by a licensed professional heating contractor.

Vitocell 100:

Viessmann recommends an annual inspection, and replacement if required, of the consumable anode by a licensed professional heating contractor.

The inspection can be carried out during regular operation of the heating system; shut-down is not required.

The heating contractor measures the protective current with an anode tester.

Drinking water filter (if installed)

For hygienic reasons

- *replace filter element every 6 months on filters which cannot be flushed back, and perform a visual inspection every 2 months,*
- *flush back reversible flow filters every 2 months.*

→ *Please follow manufacturer's instructions.*

Safety valve (DHW tank)

The safety valve function should be checked every six months by venting, either by the system user or the local heating contractor. The valve seat may become contaminated.

→ *Please follow manufacturer's instructions.*

IMPORTANT

If the domestic cold water supply to the hot water storage tank has a water treatment device (water softener) installed, ensure its proper working condition is checked regularly by your heating contractor.

The same applies if a dirt trap or a water filter is installed in the domestic cold water supply. Any of these devices installed in the domestic cold water supply must be flushed out and serviced on a regular basis.

How to Save Energy

.... by heating correctly

Apart from taking advantage of the benefits of a modern heating system, there is a lot you can do yourself to achieve additional fuel savings. For instance:

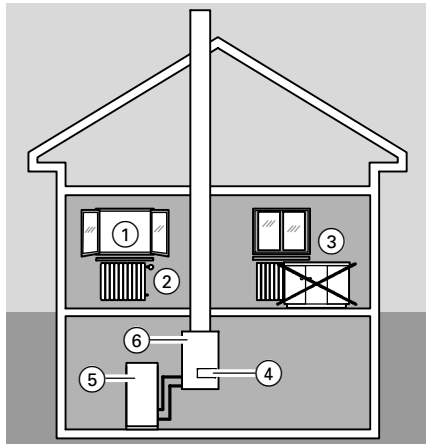

- Don't overheat:
Aim at a room temperature of 68°F / 20°C. Every degree less in room temperature will reduce your heating bills by up to 6%.
- Close window shutters ① (if installed) at dusk.
- Operate thermostatic valves ② correctly.
- Don't obstruct radiators ③ and thermostatic valves ②.
- Make use of individual adjustment options of the control unit ④; (e.g. "normal room temperature" alternating with "reduced room temperature").
- Set the domestic hot water temperature of the DHW tank ⑤ on the control unit ④.
- Control your consumption of hot water:
A shower generally consumes less energy than a bath.

... with regular maintenance

Regular maintenance check-ups of your heating system ⑥ by a licensed professional heating contractor will ensure energy savings and environmentally friendly operation.

.... with effective insulation

If you wish to make use of additional energy-saving measures, check the thermal insulation:

- of heating and domestic hot water pipes.
- of external walls and the roof.
- between heated and unheated rooms.
- of the windows.

Lighting and Operating Instructions

FOR YOUR SAFETY READ BEFORE OPERATING

W A R N I N G: If you do not follow these instructions exactly, a fire or explosion may result causing property damage, personal injury or loss of life.

- A. This appliance does not have a pilot. It is equipped with an ignition device which automatically lights the burner. Do not try to light the burner by hand.
- B. BEFORE OPERATING smell all around the appliance area for gas. Be sure to smell next to the floor because some gas is heavier than air and will settle on the floor.

WHAT TO DO IF YOU SMELL GAS

- Do not try to light any appliance.
- Do not touch any electric switch; do not use any phone in your building.
- Immediately call your gas supplier from a neighbor's phone. Follow the gas supplier's instructions.
- If you cannot reach your gas supplier, call the fire department.

- C. Use only your hand to push in or turn the gas control knob. Never use tools. If the knob will not push in or turn by hand, don't try to repair it, call a qualified service technician. Force or attempted repair may result in a fire or explosion.

- D. Do not use this appliance if any part has been under water. Immediately call a qualified service technician to inspect the appliance and to replace any part of the control system and any gas control which has been under water.

OPERATING INSTRUCTIONS

1. STOP! Read the safety information above on this label.
2. Set thermostat or other operating control to lowest setting.
3. Turn off all electric power to the appliance.
4. This appliance is equipped with an ignition device which automatically lights the burner. Do not try to light the burner by hand.

Manual gas shutoff

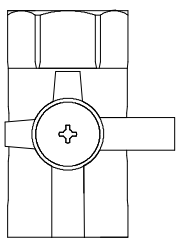

Closed

Open

5. Close main gas shut-off valve.
6. Wait five (5) minutes to clear out any gas. Then smell for gas, including near the floor. If you smell gas, STOP! Follow "B" in the safety information above on this label. If you don't smell gas, go to the next step.
7. Open main gas shut-off valve.
8. Turn on all electric power to the appliance.
9. Set thermostat or other operating control to desired setting.
10. If the appliance will not operate, follow the instructions "To Turn Off Gas To Appliance" and call your service technician or gas supplier.

TO TURN OFF GAS TO APPLIANCE

1. Set thermostat or other operating control to lowest setting.
2. Turn off all electric power to the appliance if service is to be performed.
3. Close main gas shut-off valve.







Quick Reference

°C	°F
-40	-40
-35	-31
-25	-13
-20	-4
-18	0
-16	+3
-14	+7
-12	+10
-10	+14
-9	+16
-8	+18
-7	+19
-6	+21
-5	+23
-4	+25
-3	+27
-2	+28
-1	+30
0	+32
+1	+34
+2	+36
+3	+37
+4	+39
+5	+41
+6	+43
+7	+45
+8	+46
+9	+48
+10	+50
+12	+54
+14	+57
+16	+61
+18	+64
+20	+68
+25	+77
+30	+86
+35	+95
+40	+104
+50	+122
+60	+140
+70	+158
+80	+176
+90	+194
+100	+212
+110	+230

Printed on environmentally friendly
(recycled and recyclable) paper.



Technical information subject to change without notice.